

**As you are now the owner of this document which should have come to you for free, please consider making a donation of £1 or more for the upkeep of the (Radar) website which holds this document. I give my time for free, but it costs me around £300 a year to bring this document to you. You can donate here <https://blunham.com/Radar>, thank you.**

**Do not upload this copyright pdf document to any other website. Breaching copyright may result in a criminal conviction and large payment for Royalties.**

This document was generated by me, Colin Hinson, from a document held at R.A.F. Henlow Signals Museum which is believed to be out of copyright or Crown Copyright. It is presented here (for free) under the Open Government Licence (O.G.L.) if under Crown Copyright and this version of the document is my copyright (along with the Crown Copyright) in much the same way as a photograph would be. It should be noted that most of the pages are identifiable as having been processed by me. If you believe the original document to be under copyright, please contact me.

The document should have been downloaded from my website <https://blunham.com/Radar>, or any mirror site named on that site. If you downloaded it from elsewhere, please let me know (particularly if you were charged for it). You can contact me via my Genuki email page: <https://www.genuki.org.uk/big/eng/YKS/various?recipient=colin>

**You may not copy the file for onward transmission of the data nor attempt to make monetary gain by the use of these files. If you want someone else to have a copy of the file, point them at the website (<https://blunham.com/Radar>). Please do not point them at the file itself as it may move or the site may be updated.**

---

I put a lot of time into producing these files which is why you are met with this page when you open the file.

In order to generate this file, I need to scan the pages, split the double pages and remove any edge marks such as punch holes, clean up the pages, set the relevant pages to be all the same size and alignment. I then run Omnipage (OCR) to generate the searchable text and then generate the pdf file.

Hopefully after all that, I end up with a presentable file. If you find missing pages, pages in the wrong order, anything else wrong with the file or simply want to make a comment, please drop me a line (see above).

If you find the file(s) of use to you, you might like to make a donation for the upkeep of the website – see <https://blunham.com/Radar> for a link to do so.

*Colin Hinson*

*In the village of Blunham, Bedfordshire, UK.*

AIR PUBLICATION  
**117G-0607-1**

# **SENSITIVE VALVE VOLTMETER**

**(Marconi Instruments TF2600)**

General and Technical Information

BY COMMAND OF THE DEFENCE COUNCIL

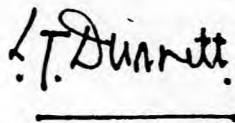
---

Ministry of Defence

FOR USE IN THE  
ROYAL AIR FORCE

(Prepared by the Ministry of Technology)

**Instruction Manual**  
**No. EB 2600**  
**for**  
**Sensitive Valve Voltmeter**  
**TF 2600**

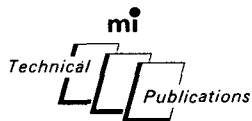

©

1968

**MARCONI INSTRUMENTS LIMITED**  
**ST. ALBANS HERTFORDSHIRE ENGLAND**



# Contents

## Chapter 1 GENERAL INFORMATION

1.1	Introduction	...	...	...	3
1.2	Data summary	...	...	...	4
1.3	Accessories	...	...	...	4

## Chapter 2 OPERATION

2.1	Preparation for use	...	...	...	5
2.2	Mains power supply	...	...	...	5
2.3	Connections	...	...	...	6
2.4	Meter readability..	...	...	...	6
2.5	Voltage measurement	...	...	...	6
2.6	Distorted waveforms	...	...	...	7

<b>Decibel conversion table</b>	...	...	...	...	8
---------------------------------	-----	-----	-----	-----	---

## Chapter 3 TECHNICAL DESCRIPTION

3.1	Input cathode follower and attenuator	...	...	...	10
3.2	Amplifier	...	...	...	10
3.3	Meter rectifier	...	...	...	11
3.4	Internal power supplies	...	...	...	11

## Chapter 4 MAINTENANCE

4.1	Introduction	...	...	...	12
4.2	Screw fasteners	...	...	...	12
4.3	Removal of case...	...	...	...	12
4.4	Performance checks	...	...	...	12
4.5	Cleaning instructions	...	...	...	13

## Chapter 5 REPAIR

5.1	Introduction	...	...	...	14
5.2	Fault finding	...	...	...	14
5.3	Component location	...	...	...	14
5.4	Realignment	...	...	...	16
5.4.1	Power supply	..	...	...	16
5.4.2	Input attenuator	...	...	...	16
5.4.3	Response	...	...	...	16

## Chapter 6 REPLACEABLE PARTS

Introduction and ordering	...	...	...	...	18
---------------------------	-----	-----	-----	-----	----

## Chapter 7 CIRCUIT DIAGRAMS

Circuit notes	...	...	...	...	21
Fig. 7.1	Circuit diagram	...	...	...	21
Fig. 7.2	Details of switch SA	..	...	...	22



## 1.1 INTRODUCTION

The TF 2600 is a wide-range a. c. voltmeter of high sensitivity and stability; 12 ranges, giving full-scale deflections from 1 mV to 300 V, enable voltages down to the order of 100  $\mu$ V to be measured.

The extensive measurement range of this instrument makes it suitable for a considerable variety of applications. With the most sensitive range having a full-scale deflection of 1 mV, measurements of small a. c. voltages can be accurately accomplished. The frequency response of audio transducers such as microphones, gramophone pick-up and tape recorder heads can be easily determined using this voltmeter to monitor the output from the transducer direct. A pick-up loop connected to the voltmeter input enables relative field strength measurements to be made. It may also be used as a sensitive balance detector for a. c. bridges. The wide range and high accuracy of the

attenuator together with the high input impedance of the voltmeter enable precise measurements of amplifier gain to be made.

An amplifier-rectifier type instrument, it maintains good accuracy with moderately distorted waveforms. A cathode follower input stage, with associated attenuators, regulates the signal level to a four-valve amplifier, the output of which energizes a moving coil meter via a full-wave crystal rectifier.

The meter is calibrated in terms of the r. m. s. value of a sine wave, but responds to the average value; it is also calibrated in decibels relative to 1 mW in 600  $\Omega$ , giving a range of -72 to +52 dBm.

The output of the amplifier section is made available at a pair of front-panel terminals. This provides a pre-amplifier facility, having a response similar to that of the instrument as a whole, with an output of up to 300 mV on any range.

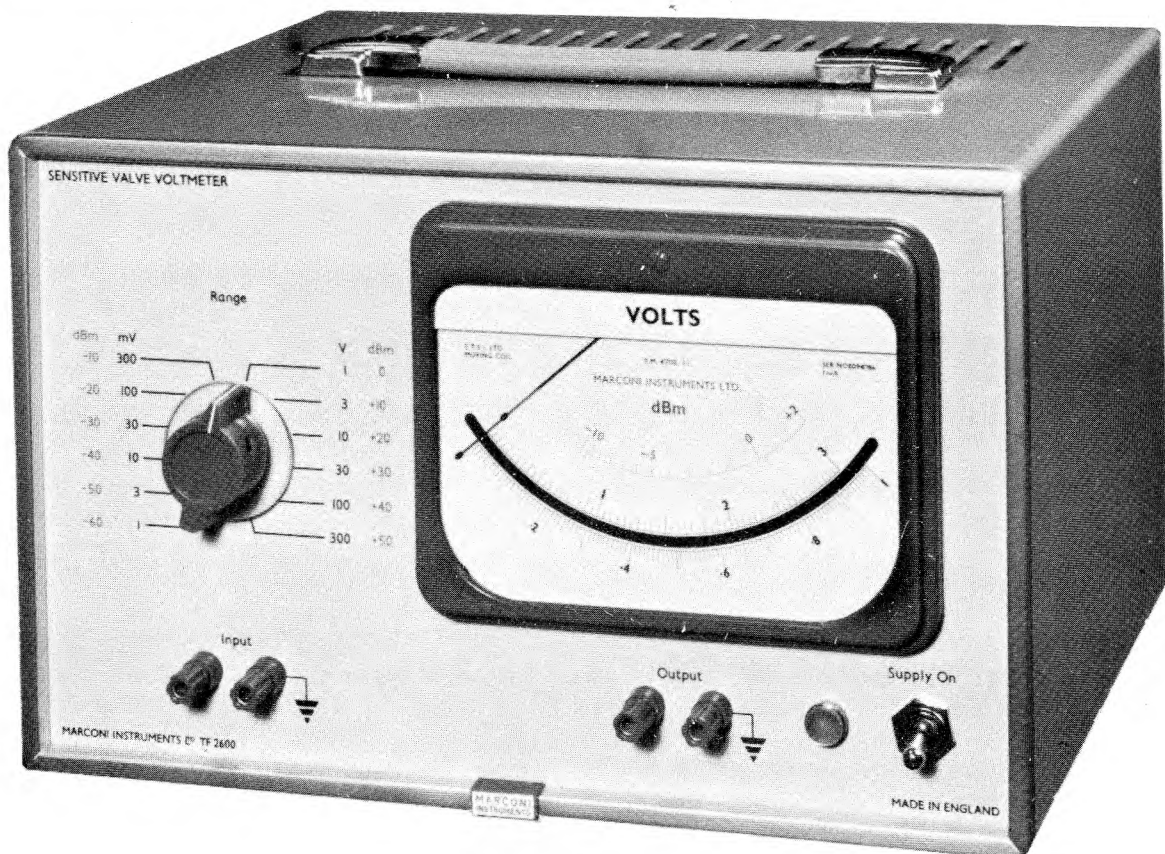

Fig. 1.1 TF 2600 Sensitive Valve Voltmeter

## 1.2 DATA SUMMARY

Voltage range:	0 to 300 V in 12 ranges, with full-scale deflections of 1, 3, 10, 30, 100 and 300 mV, and 1, 3, 10, 30, 100 and 300 V.			
Frequency range:	10 Hz to 5 MHz, with a useful response to 10 MHz.			
Measurement accuracy (at normal room temperature):	$\pm 1\%$ of full-scale, 50 Hz to 500 kHz, $\pm 2\%$ of full-scale, 20 Hz to 1 MHz, $\pm 3\%$ of full-scale, 20 Hz to 2 MHz, $\pm 5\%$ of full-scale, 10 Hz to 5 MHz.  Variation with temperature 0.02% per °C up to a maximum working ambient temperature of 50 °C.			
Stability:	A variation of $\pm 10\%$ about nominal, with 40 to 400 Hz mains supplies, will cause the meter reading to vary by less than 0.2% for 50 Hz to 500 kHz inputs. A similar reading variation will be caused by a $\pm 5\%$ change with 1000 Hz mains supplies.  Additional error of less than 1% of full-scale for measurements at or near mains supply frequency, or its second harmonic due to 'beating' effect.			
Calibration:	The meter is calibrated in terms of r. m. s. value of a sinewave, but responds to average value. Also calibrated in decibels relative to 1 mW in 600 $\Omega$ , over the range -72 to +52 dBm.			
Input impedance:	10 M $\Omega$ , shunted by about 16 pF on 1 to 300 V ranges, and by about 30 pF on 1 to 300 mV ranges.			
Amplifier output:	Output on any range for full-scale deflection on meter, approximately 160 mV; maximum output 300 mV. Output impedance 51 $\Omega$ .			
Power supply:	200 to 250 V and 100 to 130 V, 40 to 1000 Hz; 75 W. Mains input fused.			
Dimensions and weight:	<i>Height</i>	<i>Width</i>	<i>Depth</i>	<i>Weight</i>
	8 in	11½ in	11 in	17 lb
	(20.3 cm)	(29.2 cm)	(28 cm)	(7.7 kg)

## 1.3 ACCESSORIES

### Accessories available:

Low Capacitance Probe TM 8120/1: this probe is supplied in a box together with a variety of probe tips. It has an attenuator ratio of x1 and may be used for measurements up to 300 V r. m. s.

Probe Lead TM 5269: this is a low capacitance coaxial cable assembly 30 inches long, with a test prod and earth clip at one end and a Type 83 plug at the other. The input impedance is 16 pF.

A screened Adapter, Type GE 51001 (TB 39867), is available that plugs into the input terminals of the Voltmeter and has a Type 83 socket to which the probe lead may be connected.

Another similar Adapter, Type GE 51002 (TB 39868), with a BNC socket to which the low capacitance probe may be connected.

## 2.1 PREPARATION FOR USE

The mains lead is attached to the rear panel of the instrument. When fitting a suitable mains plug to it note that the earth (or chassis) conductor has a yellow designation sleeve with a green circuit earth symbol, the neutral conductor has a black sleeve with a white 'N' and the line (or phase) conductor has no sleeve.

**NOTE:** Ensure that before the instrument is switched on, the mechanical meter zero is set correctly. See Sect. 2.7 for advice on noise errors.

Before connecting the instrument to the power supply check that the input tapping and the fuse rating are correct for the supply voltage available. If they are, plug into the supply and set the SUPPLY switch to ON; the pilot lamp should now glow. Allow up to 15 minutes warm up for normal measurements. For extreme

accuracy when making comparative measurement allow at least 1 hour for the instrument to reach thermal equilibrium.

## 2.2 MAINS POWER SUPPLY

The TF 2600 may be adjusted for operation from any 40 to 1000 Hz power supply in the voltage ranges 100 to 130 V and 200 to 250 V. The two tapped primary windings on the mains transformer permit a series or series-parallel arrangement of connections. These may be selected by adjusting the position of the four plug-in links on the small panel at the rear of the instrument. These plugs make contact with the connections through a reversible masking plate as shown in Fig. 2.1.

Unless otherwise specified the instrument is normally dispatched ready for immediate operation from 240 V supplies. A single fuse is included in the power supply input, of either 1 A or 2 A rating according to the voltage range.

### SUPPLY VOLTAGE PANEL

Masking plate and links must be positioned according to supply voltage, as shown:

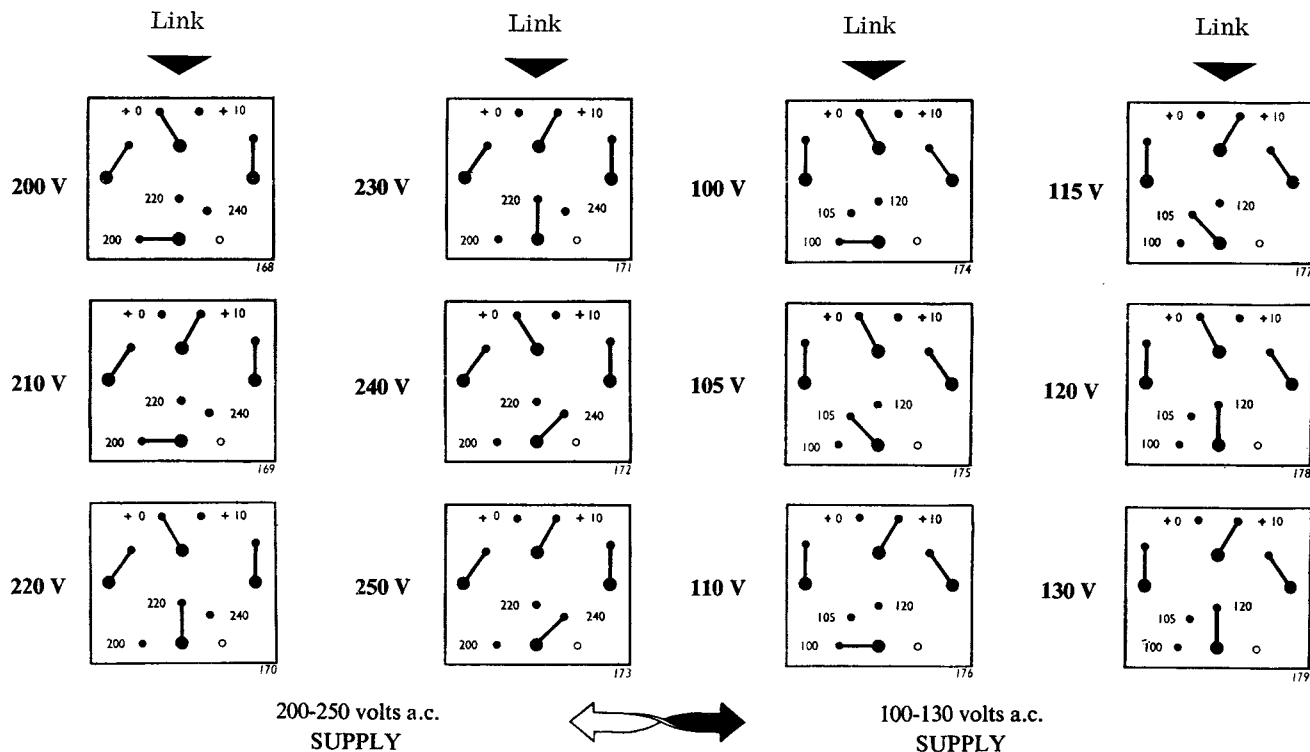

Fig. 2.1 Supply voltage panel

## 2.3 CONNECTIONS

Connection to the source of voltage to be measured or amplified is made via the INPUT terminals on the front panel of the voltmeter. In many instances a pair of unscreened leads will be quite adequate for this purpose. However, at high frequencies and at low voltage levels a screened lead will be necessary if mains hum and other spurious pick-up are not to be introduced with the wanted signal. The unscreened ends of the lead should be kept as short as possible, the screen being connected to the earth (or chassis) terminal.

A convenient form of low capacitance screened lead assembly that is available is the Probe Lead, type TM 5269. It is connected to the INPUT terminals via a screened adapter as described in Sect. 1.3. The other adapter, with a BNC socket, enables direct connection to be made via a coaxial cable to many instruments that use this standard type of connector. This adapter is essential when using the low capacitance probe described in Sect. 1.3. The TM 8120/1 probe has a distributed cable resistance and therefore does not damp fast-rise pulses. The attenuation ratio is  $\times 1$ , the input impedance (series resistance) is  $180 \Omega \pm 10 \Omega$ , and the distributed capacitance is 35 pF. The frequency response of the probe is as follows when fed from a  $50 \Omega$  source:

- (a) into 30 pF: -3 dB at 10 MHz.
- (b) into 16 pF: -3 dB at 15 MHz.

Despite observance of the precautions implied above, hum interference may still be encountered in some situations. Consideration should then be given to the earthing, particularly mains earthing, of both the equipment under test and also the valve voltmeter. If each has an individual mains earth, then there is the possibility that circulating currents will flow round the loop which is completed by the signal input connections to the valve voltmeter. In these circumstances a great improvement in conditions can generally be obtained by ensuring that there is only one connection to mains earth when the equipment under test and valve voltmeter are considered together as a single system.

### CAUTION

When measuring an a. c. voltage superimposed on a d. c. supply, the sum of the d. c. and peak a. c. voltages should not exceed 500 V.

## 2.4 METER READABILITY

The large-scale meter is provided with an anti-parallax mirror to facilitate accurate readings. For further convenience a hinged support is fitted to the underside of the case, enabling the front of the instrument to be raised so as to present the meter at an improved viewing angle.

NOTE: It should be remembered that rough handling of the instrument may be detrimental to the high accuracy of the meter.

## 2.5 VOLTAGE MEASUREMENT

The TF 2600 is suitable for measuring unbalanced a. c. voltages in the frequency range 10 Hz to 10 MHz. Measurements may be made from less than  $100 \mu\text{V}$  up to a maximum of 300 V in 12 ranges as follows:

- (1) Set the RANGE switch to the nearest range full-scale above the expected voltage level. If the level is not known, set it to the highest range.
- (2) Connect the voltmeter to the voltage source as described in Sect. 2.3.
- (3) If necessary, alter the setting of the RANGE switch to give a meter deflection in the upper two-thirds of the scale.
- (4) Read the voltage from the meter scale, and apply the multiplying factor, appropriate to the setting of the RANGE switch.

Both the meter and the RANGE switch have an auxiliary decibel calibration in red. The decibel values are with respect to 1 mW in  $600 \Omega$ , i. e., 0 dBm corresponds to 0.775 V. The value of a voltage being measured is related to this datum by taking the algebraic sum of (i) the meter reading on its red decibel scale and (ii) the decibel marking indicated by the RANGE switch.

The decibel calibrations on the voltmeter can, of course, be used when the voltage being measured is developed across an impedance other than  $600 \Omega$ , although the relationship to 1 mW is no longer valid. Provided the source impedance remains the same the difference in dB between two measurements is obtained by algebraically subtracting the decibel scale readings. They are of particular value when relative levels in successive measurements are the main concern; for instance, when determining amplifier or filter response characteristics. The decibel conversion table at the end of this chapter will be useful in this respect.

## 2.6 DISTORTED WAVEFORMS

The meter responds to the average value of the voltage under test and is calibrated in terms of the r. m. s. value of a sinusoidal input. Waveform distortion has little effect on meter reading accuracy. From Table 2.1 it will be seen that even with the extreme examples of square and triangular waveforms the inaccuracy of the r. m. s. value does not exceed 10%.

The true r. m. s. average or peak value in each case is obtained by multiplying the meter reading by the appropriate factor.

**Table 2.1**

	RMS value	Average value	Peak value
Sinusoidal waveforms	Correct reading	Reading x 0.9	Reading x 1.414
Square waveforms	Reading x 0.9	Reading x 0.9	Reading x 0.9
Triangular waveforms	Reading x 1.04	Reading x 0.9	Reading x 1.8

## 2.7 USE AS A WIDE BAND AMPLIFIER

The output of the amplifier section of the instrument is made available at a pair of front-panel terminals. This provides a convenient pre-amplifier facility which may be used to extend the sensitivity of other equipment such as cathode ray oscilloscopes and pen recorders. The response of the amplifier is similar to that of the voltmeter as a whole, and the output available is approximately 160 mV for full-scale deflection on any

range, with a maximum of about 300 mV when f. s. d. is exceeded.

Since the voltage input to the amplifier section is maintained at the same level for each range by an attenuator, the output will also be the same. At low signal levels in the amplifier some waveform distortion occurs; in order to minimize this distortion together with any hum and noise, the meter indication should be kept above one third full-scale by using the RANGE switch. The output impedance is 51  $\Omega$ .

If voltmeter readings are being observed while using the amplifier output, check for any error resulting from the output connections by temporarily disconnecting them.

## 2.8 NOISE ERROR

When the instrument is energized a meter deflection of a few percent will be observed. This is due to first circuit noise, and should not be backed off with the mechanical meter-zero as to do so would introduce a much greater error. The error only becomes significant when the applied signal is of the same order as the noise; for example, the table shows the error due to 2% circuit noise.

Signal (% of full-scale)	100	50	30	10	5
Error (% of full-scale)	0.02	0.04	0.067	0.2	0.4

To minimize the problem, work from the lowest possible signal source impedance, especially on the most sensitive ranges, and arrange leads to avoid extraneous interference pick-up.

## Decibel conversion table

<i>Ratio Down</i>			<i>Ratio Up</i>	
VOLTAGE	POWER	DECIBELS	VOLTAGE	POWER
1.0	1.0	<b>0</b>	1.0	1.0
.9886	.9772	<b>.1</b>	1.012	1.023
.9772	.9550	<b>.2</b>	1.023	1.047
.9661	.9333	<b>.3</b>	1.035	1.072
.9550	.9120	<b>.4</b>	1.047	1.096
.9441	.8913	<b>.5</b>	1.059	1.122
.9333	.8710	<b>.6</b>	1.072	1.148
.9226	.8511	<b>.7</b>	1.084	1.175
.9120	.8318	<b>.8</b>	1.096	1.202
.9016	.8128	<b>.9</b>	1.109	1.230
.8913	.7943	<b>1.0</b>	1.122	1.259
.8710	.7586	<b>1.2</b>	1.148	1.318
.8511	.7244	<b>1.4</b>	1.175	1.380
.8318	.6918	<b>1.6</b>	1.202	1.445
.8128	.6607	<b>1.8</b>	1.230	1.514
.7943	.6310	<b>2.0</b>	1.259	1.585
.7762	.6026	<b>2.2</b>	1.288	1.660
.7586	.5754	<b>2.4</b>	1.318	1.738
.7413	.5495	<b>2.6</b>	1.349	1.820
.7244	.5248	<b>2.8</b>	1.380	1.905
.7079	.5012	<b>3.0</b>	1.413	1.995
.6683	.4467	<b>3.5</b>	1.496	2.239
.6310	.3981	<b>4.0</b>	1.585	2.512
.5957	.3548	<b>4.5</b>	1.679	2.818
.5623	.3162	<b>5.0</b>	1.778	3.162
.5309	.2818	<b>5.5</b>	1.884	3.548
.5012	.2512	<b>6</b>	1.995	3.981
.4467	.1995	<b>7</b>	2.239	5.012
.3981	.1585	<b>8</b>	2.512	6.310
.3548	.1259	<b>9</b>	2.818	7.943
.3162	.1000	<b>10</b>	3.162	10.000
.2818	.07943	<b>11</b>	3.548	12.59
.2512	.06310	<b>12</b>	3.981	15.85
.2239	.05012	<b>13</b>	4.467	19.95
.1995	.03981	<b>14</b>	5.012	25.12
.1778	.03162	<b>15</b>	5.623	31.62

## DECIBEL CONVERSION TABLE (continued)

Ratio Down			Ratio Up	
VOLTAGE	POWER	DECIBELS	VOLTAGE	POWER
·1585	·02512	<b>16</b>	6·310	39·81
·1413	·01995	<b>17</b>	7·079	50·12
·1259	·01585	<b>18</b>	7·943	63·10
·1122	·01259	<b>19</b>	8·913	79·43
·1000	·01000	<b>20</b>	10·000	100·00
·07943	$6·310 \times 10^{-3}$	<b>22</b>	12·59	158·5
·06310	$3·981 \times 10^{-3}$	<b>24</b>	15·85	251·2
·05012	$2·512 \times 10^{-3}$	<b>26</b>	19·95	398·1
·03981	$1·585 \times 10^{-3}$	<b>28</b>	25·12	631·0
·03162	$1·000 \times 10^{-3}$	<b>30</b>	31·62	1,000
·02512	$6·310 \times 10^{-4}$	<b>32</b>	39·81	$1·585 \times 10^3$
·01995	$3·981 \times 10^{-4}$	<b>34</b>	50·12	$2·512 \times 10^3$
·01585	$2·512 \times 10^{-4}$	<b>36</b>	63·10	$3·981 \times 10^3$
·01259	$1·585 \times 10^{-4}$	<b>38</b>	79·43	$6·310 \times 10^3$
·01000	$1·000 \times 10^{-4}$	<b>40</b>	100·00	$1·000 \times 10^4$
$7·943 \times 10^{-3}$	$6·310 \times 10^{-5}$	<b>42</b>	125·9	$1·585 \times 10^4$
$6·310 \times 10^{-3}$	$3·981 \times 10^{-5}$	<b>44</b>	158·5	$2·512 \times 10^4$
$5·012 \times 10^{-3}$	$2·512 \times 10^{-5}$	<b>46</b>	199·5	$3·981 \times 10^4$
$3·981 \times 10^{-3}$	$1·585 \times 10^{-5}$	<b>48</b>	251·2	$6·310 \times 10^4$
$3·162 \times 10^{-3}$	$1·000 \times 10^{-5}$	<b>50</b>	316·2	$1·000 \times 10^5$
$2·512 \times 10^{-3}$	$6·310 \times 10^{-6}$	<b>52</b>	398·1	$1·585 \times 10^5$
$1·995 \times 10^{-3}$	$3·981 \times 10^{-6}$	<b>54</b>	501·2	$2·512 \times 10^5$
$1·585 \times 10^{-3}$	$2·512 \times 10^{-6}$	<b>56</b>	631·0	$3·981 \times 10^5$
$1·259 \times 10^{-3}$	$1·585 \times 10^{-6}$	<b>58</b>	794·3	$6·310 \times 10^5$
$1·000 \times 10^{-3}$	$1·000 \times 10^{-6}$	<b>60</b>	1,000	$1·000 \times 10^6$
$5·623 \times 10^{-4}$	$3·162 \times 10^{-7}$	<b>65</b>	$1·778 \times 10^3$	$3·162 \times 10^6$
$3·162 \times 10^{-4}$	$1·000 \times 10^{-7}$	<b>70</b>	$3·162 \times 10^3$	$1·000 \times 10^7$
$1·778 \times 10^{-4}$	$3·162 \times 10^{-8}$	<b>75</b>	$5·623 \times 10^3$	$3·162 \times 10^7$
$1·000 \times 10^{-4}$	$1·000 \times 10^{-8}$	<b>80</b>	$1·000 \times 10^4$	$1·000 \times 10^8$
$5·623 \times 10^{-5}$	$3·162 \times 10^{-9}$	<b>85</b>	$1·778 \times 10^4$	$3·162 \times 10^8$
$3·162 \times 10^{-5}$	$1·000 \times 10^{-9}$	<b>90</b>	$3·162 \times 10^4$	$1·000 \times 10^9$
$1·000 \times 10^{-5}$	$1·000 \times 10^{-10}$	<b>100</b>	$1·000 \times 10^5$	$1·000 \times 10^{10}$
$3·162 \times 10^{-6}$	$1·000 \times 10^{-11}$	<b>110</b>	$3·162 \times 10^5$	$1·000 \times 10^{11}$
$1·000 \times 10^{-6}$	$1·000 \times 10^{-12}$	<b>120</b>	$1·000 \times 10^6$	$1·000 \times 10^{12}$
$3·162 \times 10^{-7}$	$1·000 \times 10^{-13}$	<b>130</b>	$3·162 \times 10^6$	$1·000 \times 10^{13}$
$1·000 \times 10^{-7}$	$1·000 \times 10^{-14}$	<b>140</b>	$1·000 \times 10^7$	$1·000 \times 10^{14}$

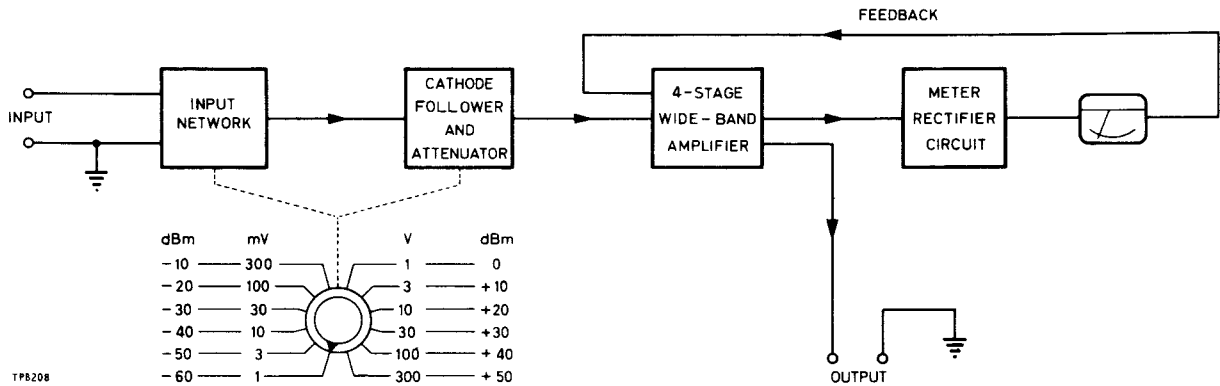

Fig. 3.1 Block diagram

It is suggested that the following sections be read in conjunction with the circuit diagram included at the end of this manual.

### 3.1 INPUT CATHODE FOLLOWER AND ATTENUATOR

Fig. 3.1 shows a block diagram of the voltmeter. The circuit consists of a cathode follower input stage feeding a four-valve amplifier, the output of which energizes a moving-coil meter via a full-wave crystal rectifier.

The input cathode follower is used to provide a high input impedance. It is preceded by an attenuator that reduces the input by 60 dB on ranges above 300 mV. This attenuator comprises a 10 MΩ carbon film high stability resistor, R2, with compensating capacitors C10 and C3, and resistors R3, RV1, and thermistor TH1, used to match the temperature coefficient of R2. Above about 10 kHz the attenuation is determined by the capacitors C10, C3 and C4. Resistors R5, R67 and R68 in parallel are added to damp out any series resonance effect at 5 MHz due to residual inductance.

The output of the cathode follower is fed to another compensated attenuator, which, in conjunction with the first attenuator, maintains a constant input to the amplifier section for each voltage range. This second attenuator is made up of special close tolerance wire wound resistors to minimize switching errors between ranges.

The high accuracy of the attenuators enables the measurement of gain in amplifiers to be made with precision.

### 3.2 AMPLIFIER

The four-valve R-C coupled amplifier, V2 to V5, employs a system of staggered time constants so that the required overall response is achieved without recourse to stage-by-stage corrective feedback. This system gives a controlled fall-off in gain at the extremities of the frequency range without excessive phase shift (see Fig. 3.2). The amplifier gain, however, is

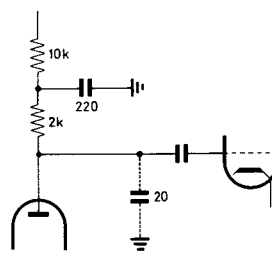
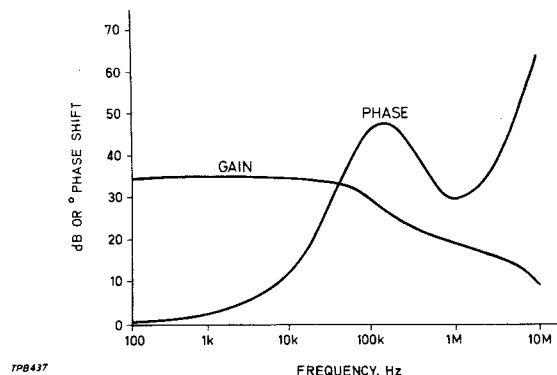

Fig. 3.2  
Gain and phase shift curves of a typical amplifier stage



TPB437

controlled by overall negative feedback taken from the meter rectifier circuit and applied to the cathode of the first amplifier valve. This is adjusted by RV4 to give correct meter indication for a standard signal.

The low-frequency response is controlled by RV2 and RV5; RV2 setting the phase shift and RV5 the gain. These two interact, and correct adjustment will give the required response down to 10 Hz whilst giving good meter damping at the lowest frequencies.

Phase shift at high frequencies is controlled by the valve capacitances, and also by L1, L2 and C28 in the feedback network. The bias for V3, V4 and V5 is set by RV3 to even out effects of valve variations, a nominal setting of +3 V is used with slight adjustments to suit the h. f. response.

The amplifier output is made available at a pair of front-panel terminals, giving approximately 160 mV for full scale deflection on any range. The output is taken from across a 51  $\Omega$  resistor in the cathode circuit of V5.

### 3.3 METER RECTIFIER

The output from V5 anode is applied to a full-wave bridge comprising two silicon diodes and two

capacitors. Each diode conducts on alternate half-cycles, and the capacitors are continuously discharged by the meter to give average level rectification. At the crossover point neither diode conducts properly, and their impedance is very high. Since the amplifier feedback voltage is taken from the rectifier circuit this non-linearity will cause some waveform distortion in the amplifier output. This distortion, together with any hum and noise, will be minimized by keeping the signal level in the amplifier of sufficient amplifier to give a meter deflection above one-third full scale.

### 3.4 INTERNAL POWER SUPPLIES

Good stability of meter indication is ensured by the use of a series-valve stabilizer circuit to regulate the h. t. supply for the instrument. The heater supply for the cathode follower and first three amplifier valves is rectified, smoothed, and fed to the heaters in a series-parallel connection in order to minimize hum pick-up in the valve. The heater supply for the h. t. regulator valves is biased positively to reduce the heater-cathode voltage to a safe level.

The mains transformer has been given a generous-sized core and has been specially orientated so that a minimum amount of mains hum is induced into the circuit.

#### 4.1 INTRODUCTION

This chapter contains information for keeping the equipment in good working order and for checking its overall performance.

Before attempting any maintenance on the voltmeter you are advised to read the preceding technical description.

In case of difficulties that cannot be cleared by means of this manual, or for general advice on servicing the instrument, please write to or telephone our Service Division or Agent. Always mention the type number and serial number of your instrument.

If the instrument is being returned for repair, please indicate clearly the nature of the fault or the work you require to be done.

#### 4.2 SCREW FASTENERS

Screw threads on this instrument are of the following sizes: 2BA, 4BA, 6BA, 8BA.

All screws are either cheesehead slotted or countersunk slotted. Care must be taken that the correct size screwdriver is used, particularly with countersunk screws.

#### 4.3 REMOVAL OF CASE

The main case assembly is clamped to the front-panel frame by the rear case panel. This panel may be removed after unscrewing the two centrally located knurled-head screws, and the main case then separated from the chassis. This gives access to all components except those on the 60 dB input network board. The input network is made available by removing the small cover on the bottom of the instrument.

#### 4.4 PERFORMANCE CHECKS

The following checks may be carried out without removing the instrument from its case. Performance limits quoted in this section and in Sect. 5.4 are for guidance only and should not be taken as guaranteed performance specifications unless they are also quoted in Data Summary, Sect. 1.2.

##### Test equipment required

The list that follows contains equipment required for the checks detailed in this Section and for realignment procedures detailed in Sect. 5.4.

<i>Item</i>	<i>Type</i>	<i>Minimum specification</i>	<i>Recommended model</i>
a	Voltmeter calibrator	1 mV to 300 V at 400 Hz	Bradley 125B
b	Multimeter		Avometer model 8
c	Mains Variac	±10% of supply voltage	
d	Valve voltmeter	300 mV	<b>mi</b> TF 2604
e	Universal bridge		<b>mi</b> TF 2700, TF 1313
f	L. F. oscillator	50 Hz - 100 Hz, output 1 mV - 1 V	<b>mi</b> TF 2100 series
g	Oscilloscope	General purpose	<b>mi</b> TF 2200 series
h	R-C oscillator	1 kHz, output 1 mV - 100 mV	<b>mi</b> TF 1101
i	Ballantine micropotentiometer		Model 440
j	Wide range R-C oscillator	10 Hz to 10 MHz	<b>mi</b> TF 1370A

### Voltage range

Test equipment: a

Set the calibrator to 400 Hz and set the output voltage to 1 mV. Switch the voltmeter to the 1 mV range.

Ensure that the voltmeter is correctly zeroed. Connect the output from the calibrator to the voltmeter and check that the reading is correct within  $\pm 1\%$  of full-scale.

Repeat this check for each position of the voltmeter range making sure that you switch to the next range on the voltmeter before increasing the output of the calibrator.

### Stability

Test equipment: c and h

Plug the voltmeter into the Variac, which should be set to the mains supply voltage. Set the oscillator to 1 kHz 1 V output and connect to the voltmeter. Set a convenient reading on the meter.

Vary the supply voltage  $\pm 10\%$  about the nominal voltage. Check that the meter reading varies by less than 0.2% for any 10% change in supply voltage.

Set the oscillator to 50 Hz and 100 Hz and repeat the check. An additional error of not more than 1% of full-scale may result due to the mains beating effect.

NOTE: Avoid magnetic hum pick-up direct from the variac.

### Input impedance

Test equipment: a

Set the calibrator to 400 Hz and an output of 1 V. Connect it to the voltmeter and set the RANGE switch to 1 V. Insert an accurate ( $\pm 1\%$ ) 10 M $\Omega$  resistor between the generator and the voltmeter. Note the reading on the meter keeping the generator output level constant.

The input impedance is given by:

$$\frac{R1 \times E2}{E1 - E2}$$

where R1 = 10 M $\Omega$  resistor, E1 = 1 V and E2 = reading with 10 M $\Omega$  inserted.

The input impedance at 400 Hz should be greater than 8.5 M $\Omega$ .

### Output resistance

Test equipment: e

Connect the bridge across the OUTPUT terminals of the voltmeter and measure the resistance. This should be 51  $\Omega$   $\pm 5\%$ .

### Amplifier gain

Test equipment: d, g and h

Set the voltmeter to the 1 mV range and the oscillator to 400 Hz 1 mV output. Connect the oscillator to the voltmeter INPUT terminals and adjust it to give a full-scale deflection on the voltmeter. Connect the valve voltmeter to the TF 2600 OUTPUT terminals and check that the output is greater than 150 mV.

Set the voltmeter RANGE switch to 100 mV and connect the oscilloscope to the OUTPUT terminals. Set the oscillator for an output of 100 mV at 1 kHz and view the resulting trace on the oscilloscope. Increase the output from the oscillator until the trace starts to distort. The output from the voltmeter should then be greater than 300 mV.

## 4.5 CLEANING INSTRUCTIONS

If it is necessary to clean the contacts of the rotary RANGE switch, this should be done with benzine or white spirit (not carbon tetrachloride), and the contacts should afterwards be wiped with a suitable lubricant such as a 1% solution of petroleum jelly in white spirit. Avoid lubricants containing soap or solid materials.

The instrument should be periodically blown out and dusted internally with a soft brush (i. e. clean paint brush).

## 5.1 INTRODUCTION

This chapter is intended to help you to fault find, carry out internal checks or realign the instrument. The realignment section is based on the company test schedule to which the voltmeter was produced and contains details concerning the adjustment of preset components.

Details of case removal and advice on screw fasteners are given in the previous chapter.

## 5.2 FAULT FINDING

This section includes an easy to follow fault finding chart that will enable you to localize a fault in the instrument. The chart provides some information referring to the realignment of preset

components; this is only intended as a guide. If the fault appears to be a mis-alignment condition you should refer to Sect. 5.4.

The most likely need for maintenance is expected to be due to the failure of a valve. The amplifier has been designed to be independent of individual valve characteristics, but those used for V1 or V2 may need to be selected for low microphony and hum. Any replacement valves should be aged at their normal working voltages and any adjustments made with the instrument in its normal upright position. Most presets are marked with their circuit designations and function. Potentiometers RV2, RV3 and RV5 are located on the rear panel under a detachable cover-plate.

## 5.3 COMPONENT LOCATION

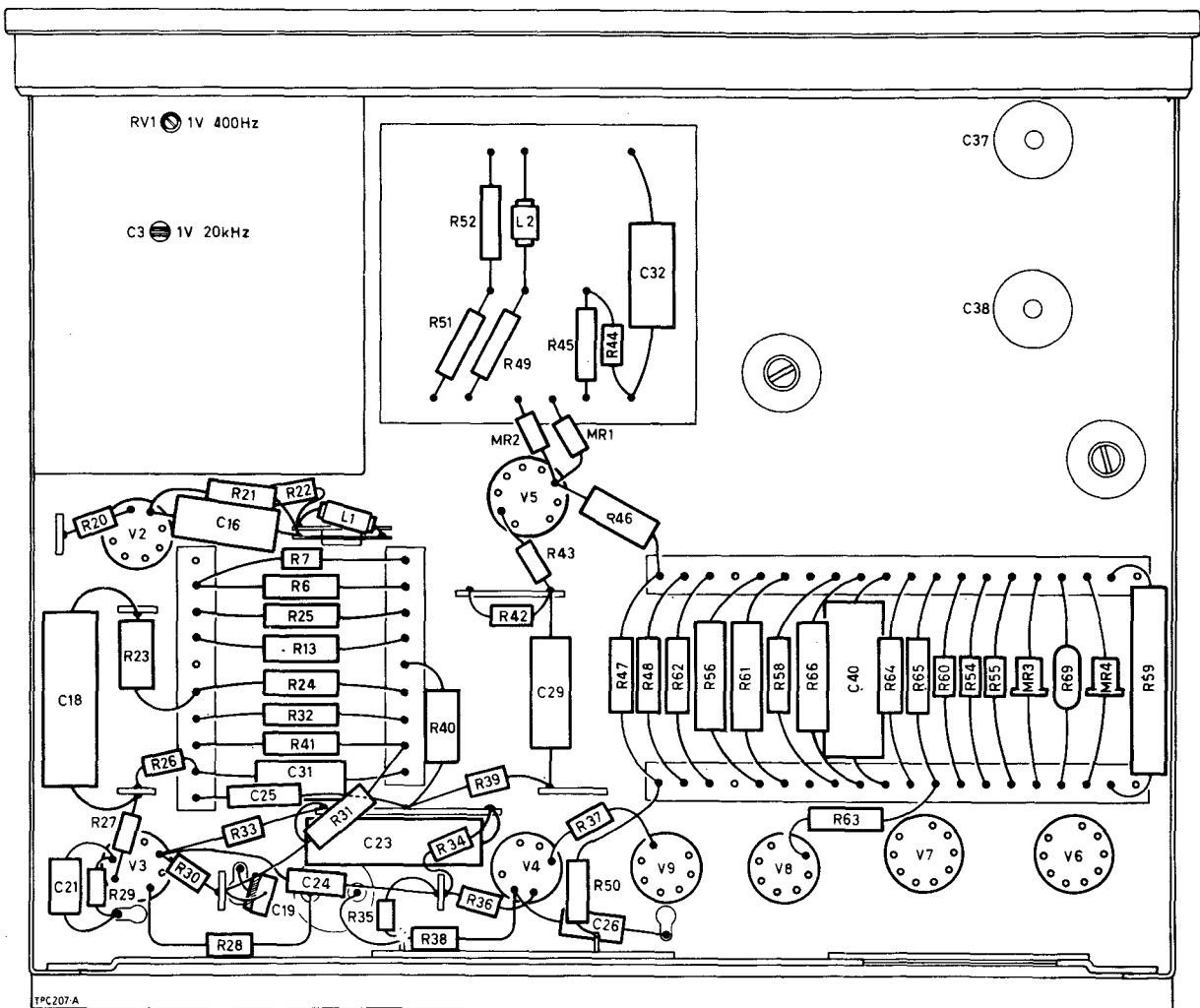
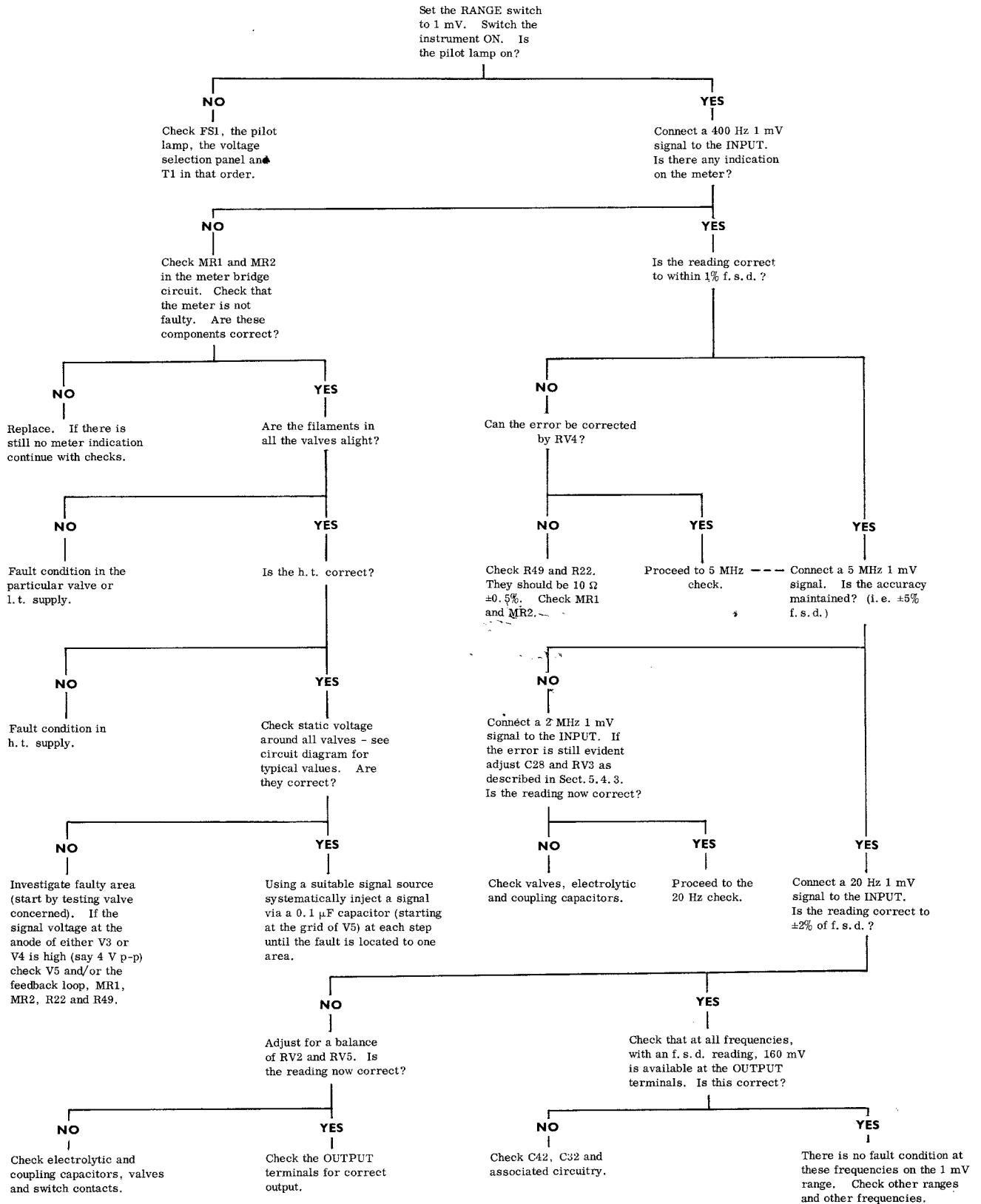

Fig. 5.1 Location of components



NOTES: (1) Valves V1 and V2 are low microphony valves. To check that they are within specification, set to the 1 mV range, disconnect any signal and short the INPUT terminals together. Give the meter a sharp 'rap' with the knuckles. Check that the meter deflection is not greater than 10% f.s.d. If microphony is evident try either interchanging V1 and V2 with V3 and V4, or replace V1 and V2.

(2) RV3 affects all ranges and response at all frequencies. If this preset is adjusted for a flat response at 2 MHz or 5 MHz on the 1 mV range, check other ranges.

Fig. 5.2 Fault finding chart

## 5.4 REALIGNMENT

See Sect. 4.4 for list of test equipment and significance of quoted limits.

### 5.4.1 Power supply

Test equipment: d

Connect the voltmeter at a convenient point between the stabilized h. t. line and earth. Measure the hum level, which should be less than 3 mV r. m. s. If the hum level is too high select R62 (in the anode circuit of V8) for a minimum hum level. If selection of R62 does not reduce the hum, select the voltage stabilizer V9 for the required level.

Connect the voltmeter across C38. Measure the hum level, which should be less than 25 mV r. m. s. If greater, check C37, C38 or bad earthing in the associated circuitry.

### 5.4.2 Input attenuator

Test equipment: a

Set the voltmeter RANGE switch to 1 mV. Set the calibrator to 1 kHz 1 mV output and connect to the INPUT terminals. Set the meter exactly to full-scale by adjusting RV4. Check the tracking of the RANGE switch up to 300 mV by switching in turn the RANGE switch of the voltmeter and the output of the calibrator. The error should be less than  $\pm 0.2\%$ .

Set the generator for an output of 1 V and switch the voltmeter RANGE to 1 V. Set the meter exactly to full-scale by adjusting RV1. Check the tracking of the RANGE switch up to 300 V using the same method as above. The error should be less than  $\pm 0.2\%$ .

### 5.4.3 Response

Test equipment: a, i, j

Connect up the test equipment as shown after decreasing the output level of the oscillator to below 1 mV.

1 mV range at r. f.

Set the frequency of the oscillator to 400 Hz and the level to provide 0.9 mV on the voltmeter. Note the indication on the galvanometer.

Set the oscillator to 5 MHz and adjust the output level to produce the same reading as before on the galvanometer. Adjust C28 to produce a reading on the voltmeter of 0.9 mV at 5 MHz.

Intermediate points may be checked, i. e. 30 kHz, 500 kHz, 1 MHz and 2 MHz. If the response at 2 MHz or other frequencies is incorrect, readjust C28 and RV3. The overall response limits are as follows:

Table 5.1

50 Hz to 500 kHz	$\pm 1\%$ of full-scale
20 Hz to 1 MHz	$\pm 2\%$ of full-scale
20 Hz to 2 MHz	$\pm 3\%$ of full-scale
10 Hz to 5 MHz	$\pm 4\%$ of full-scale

Checks can be made on frequency response up to 10 MHz but the response limits should not exceed  $\pm 10\%$ .

NOTE: RV3 is the bias control. If an excessive response dip is evident at 2 MHz (when the level is set at 0.9 mV at 5 MHz) reduce the positive bias. If an excessive response rise is found at this point increase the positive bias.

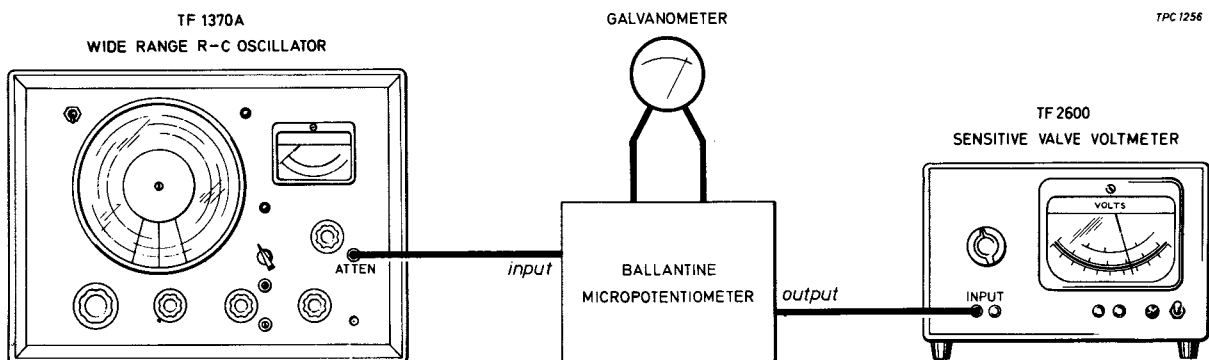

Fig. 5.3 Test arrangement for frequency response

1 mV range at a. f.

Test equipment: a, i, j

Set up the test equipment as before and obtain a level on the galvanometer at 400 Hz 0.9 mV. Adjust the oscillator frequency to 20 Hz maintaining the same galvanometer reading, and set RV2 to obtain 0.9 mV on the voltmeter, similarly adjust RV5 for the same level at 10 Hz. RV2 and RV5 interact and adjustment requires repeating for optimum response. The overall response limit is  $\pm 1\%$  of full-scale.

NOTE: Supply frequency beating at 50 Hz, 100 Hz, 150 Hz and 200 Hz may affect the accuracy of the readings.

3 mV to 300 mV ranges at r. f.

Test equipment: a, i, j

Set up the test equipment as before and set

the oscillator frequency to 30 kHz. Switch the voltmeter to the 3 mV range, adjust the oscillator output until the voltmeter is deflected to 0.9 on the 0-1 scale and note the corresponding galvanometer indication.

Adjust the oscillator frequency to 5 MHz, maintaining the same galvanometer reading, and set C14 to obtain 0.9 indication on the voltmeter. Check the response at intermediate frequencies and, if the error exceeds the limits in Table 5.1, make further slight adjustment to C14.

Repeat the procedure for the 10 mV range, adjusting C13. Similarly, adjust C11 for the best response on the three ranges 30, 100 and 300 mV.

NOTE: Different micropotentiometers (since each covers a fairly small voltage range) may be required for this procedure.

# Replaceable parts

## Introduction

This chapter lists replaceable parts in alphabetical order of their circuit references, with miscellaneous parts at the end of the list. The following abbreviations and symbols are used:-

C	: capacitor
Carb	: carbon
Cer	: ceramic
Elec	: electrolytic
FS	: fuse
L	: inductor
Log	: logarithmic
M	: meter
Met	: metal
Min	: minimum value
MR	: semiconductor diode
Ox	: oxide
PL	: plug
Plas	: plastic
R	: resistor
RV	: variable resistor
S	: switch
SKT	: socket
T	: transformer
TH	: thermistor
V	: valve
Var	: variable
WW	: wirewound
†	: value selected during test, nominal value listed.
W	: watts at 70 °C
W*	: watts at 55 °C
W**	: watts at 40 °C
W***	: watts at 20 °C
W <sup>o</sup>	: watts at unspecified temperature.

## Ordering

Send your order for replacement parts to our Service Division at the address given on the back cover. Specify the following information for each part required.

1. Type and serial number of instrument.
2. Circuit reference.
3. Description.
4. M.I. code number

If a part is not listed, state its function, location and description when ordering.

Circuit reference	Description	M.I. code
C1	Plas 0.047μF 500V	26134-446
C2	Mica 47pF 5% 350V	26266-014
C3	Cer 0.7-4pF var.	26872-104
C4	Mica 4700pF 5% 350V	26266-745
C5	Plas 0.0068μF 5% 160V	26511-164
C6	Elec 40μF 275V	26437-858
C7	Plas 0.05μF 10% 350V	26112-458
C8	Elec 25μF +100-20% 50V	26417-145
C9	Elec 25μF +100-20% 50V	26417-145
C10	Cer 2.2pF 10% 750V	26321-029
C11	Cer 5-40pF var.	26844-407
C12	Cer 10pF ±0.5pF 750V	26324-085
C13	Cer 5-40pF var.	26844-407
C14	Cer 3-30pF var.	26844-405
C15	Elec 40μF 275V	26437-858
C16	Plas 0.47μF 10% 250V	26511-374
C18	Plas 0.1μF 10% 350V	26134-455
C19	Cer 220pF 10% 350V	26224-450
C20	Elec 2000μF 12V	26437-107
C21	Plas 0.068μF 10% 250V	26511-345
C23	Plas 0.1μF 10% 350V	26134-455
C24	Plas 3300pF 10% 500V	26511-130
C25	Cer 56pF 2½% 750V	26322-127
C26	Plas 0.068μF 10% 250V	26511-345
C28	Cer 5-40pF var.	26844-407
C29	Plas 0.022μF 10% 400V	26512-208
C30	Elec 40μF 500V	26437-837
C31	Elec 50μF +100-20% 12V	26417-152
C32	Plas 1μF 10% 250V	26511-382
C34	Elec 1000μF +50-20% 12V	26417-403
C35	Plas 2μF 10% 250V	26558-235
C36	Plas 2μF 10% 250V	26558-235
C37	Elec 3000μF 15V	26417-256
C38	Elec 3000μF 15V	26417-256
C40	Plas 0.1μF 10% 350V	26134-455
C41	Cer 27pF 5% 750V	26324-812
C42	Elec 6.8μF 20% 6V	26487-274

Circuit reference	Description	M.I. code	Circuit reference	Description	M.I. code
FS1	1A for 200V mains 2A for 100V mains	23411-058	R24	Met ox 8.2k $\Omega$ 5% 2W <sup>0</sup>	24587-248
		23411-060	R25	Carb 4.7k $\Omega$ 10% 1W*	24343-126
L1	0.13 $\mu$ H	44123-601	R26	Carb 1.2M $\Omega$ 10% $\frac{1}{2}$ W*	24342-168
L2	0.13 $\mu$ H	44123-601	R27	Carb 4.7 $\Omega$ 10% $\frac{1}{2}$ W*	24342-037
M1	1mA F.S.D. 5"	44562-402	R28	Carb 3 $\Omega$ $\pm\frac{1}{2}\Omega$ $\frac{1}{4}$ W <sup>0</sup>	24332-407
			R29	Carb 560 $\Omega$ 10% $\frac{1}{2}$ W*	24342-072
MR1	Silicon crystal diode Hughes HD5004	28335-235	R30	Met ox 2k $\Omega$ 7% $\frac{3}{8}$ W*	24552-087
			R31	Met ox 10k $\Omega$ 5% 2W <sup>0</sup>	24587-250
MR2	Silicon junction diode 1N540	28357-048	R32	Carb 4.7k $\Omega$ 10% 1W*	24343-126
MR3			R33	Carb 3.3M $\Omega$ 10% $\frac{1}{2}$ W*	24342-178
MR4			R34	Carb 2.7M $\Omega$ 10% $\frac{1}{2}$ W*	24342-176
			R35	Carb 4.7k $\Omega$ 10% $\frac{1}{2}$ W*	24342-126
PLP1	8V 0.15A L.S.C.	44731-003	R36	Carb 4.7 $\Omega$ 10% $\frac{1}{2}$ W*	24342-037
			R37	Carb 560 $\Omega$ 10% $\frac{1}{2}$ W*	24342-072
R1	Carb 4.7 $\Omega$ 10% $\frac{1}{2}$ W*	24342-037	R38	Carb 3 $\Omega$ $\pm\frac{1}{2}\Omega$ $\frac{1}{4}$ W <sup>0</sup>	24332-407
			R39	Met ox 2k $\Omega$ 7% $\frac{3}{8}$ W*	24552-087
R2	Carb 10M $\Omega$ 1% W <sup>0</sup>	24269-891	R40	Met ox 10k $\Omega$ 5% 2W <sup>0</sup>	24587-250
R3	Carb 9.36k $\Omega$ 1% W <sup>0</sup>	24154-936	R41	Carb 4.7k $\Omega$ 10% 1W*	24343-126
R4	Met ox 15k $\Omega$ 5% $\frac{3}{8}$ W*	24552-114	R42	Carb 560k $\Omega$ 10% $\frac{1}{2}$ W*	24342-155
R5 †	Carb 18 $\Omega$ $\frac{1}{2}$ W*	24342-026	R43	Carb 4.7 $\Omega$ 10% $\frac{1}{2}$ W*	24342-037
R6	Carb 220k $\Omega$ 10% 1W*	24342-143	R44	Met ox 300 $\Omega$ 5% $\frac{1}{4}$ W <sup>0</sup>	24552-062
R7	Carb 110k $\Omega$ 5% $\frac{1}{4}$ W <sup>0</sup>	24332-136	R45	Carb 51 $\Omega$ 5% $\frac{1}{2}$ W <sup>0</sup>	24335-629
R8	Carb 8.2M $\Omega$ 10% $\frac{1}{2}$ W*	24342-189	R46	Met ox 10k $\Omega$ 5% 2W <sup>0</sup>	24587-250
R9	Carb 2.2M $\Omega$ 10% $\frac{1}{2}$ W*	24342-174	R47	Carb 3.3k $\Omega$ 10% 1W*	24343-094
R10	Carb 4.70 $\Omega$ 10% $\frac{1}{2}$ W*	24342-069	R48	Carb 33k $\Omega$ 10% 1W*	24343-122
R11	Carb 6.8k $\Omega$ 10% 2W**	24347-706	R49	Met ox 10 $\Omega$ 0.5% $\frac{1}{4}$ W	24634-103
R12	Carb 4.7k $\Omega$ 10% 1W*	24343-126	R50	Carb 220k $\Omega$ 10% 1W*	24343-143
R13	Met ox 8.2k $\Omega$ 5% 2W <sup>0</sup>	24587-248	R51	Met ox 205 $\Omega$ $\frac{1}{2}$ % $\frac{1}{2}$ W <sup>0</sup>	24654-602
R14	WW 4.2k $\Omega$ 0.1%	44358-012	R52	Met ox 4.0 $\Omega$ 1% $\frac{1}{2}$ W <sup>0</sup>	24656-226
R15	WW 1327 $\Omega$ 0.1%	44358-011	R53	Carb 1.8k $\Omega$ 10% $\frac{1}{4}$ W <sup>0</sup>	24342-086
R16	WW 420 $\Omega$ 0.1%	44358-010	R54	Carb 4.70k $\Omega$ 10% $\frac{1}{2}$ W*	24342-152
R17	WW 132.7 $\Omega$ 0.1%	44358-009	R55	Carb 4.70k $\Omega$ 10% $\frac{1}{2}$ W*	24342-152
R18	WW 42 $\Omega$ 0.1%	44358-005	R56	Carb 220k $\Omega$ 10% 1W <sup>0</sup>	24347-743
R19	WW 19.47 $\Omega$ 0.1%	44356-007	R57	Carb 22 $\Omega$ 10% 1W*	24343-028
R20	Carb 4.7 $\Omega$ 10% $\frac{1}{2}$ W*	24342-037	R58	Carb 100k $\Omega$ 10% 1W*	24343-135
R21	Carb 120 $\Omega$ 10% 1W*	24343-052	R59	WW 6.3k $\Omega$ 10% 10W <sup>0</sup>	25338-643
R22	Met ox 10 $\Omega$ 0.5% $\frac{1}{4}$ W	24634-103	R60	Carb 4.70 $\Omega$ 10% $\frac{1}{2}$ W*	24342-069
R23	Met ox 8.2k $\Omega$ 5% 2W <sup>0</sup>	24587-248	R61	Carb 56k $\Omega$ 10% 1W <sup>0</sup>	24347-729
			R62 †	Carb 4.70k $\Omega$ 10% 1W*	24343-152

For symbols and abbreviations see introduction to this chapter

Replaceable parts

Circuit reference	Description	M.I. code	Circuit reference	Description	M.I. code
R63	Carb 330k $\Omega$ 10% 1W*	24343-148	TH1	VA1046	25685-478
R64	Met ox 166k $\Omega$ 1% W <sup>o</sup>	24266-166			
R65	Met ox 83.5k $\Omega$ 1% W <sup>o</sup>	24265-835			
R66	Carb 68k $\Omega$ 10% 1W <sup>o</sup>	24347-731	V1	6CB6A	28152-537
R67	Carb 10 $\Omega$ 10% $\frac{1}{2}$ W*	24342-020	V2	6CB6A	28152-537
R68	Carb 10 $\Omega$ 10% $\frac{1}{2}$ W*	24342-020	V3	6CB6A	28152-537
R69	WW 4 $\Omega$ 5% 3W***	25125-312	V4	6CB6A	28152-537
R70	Carb 390 $\Omega$ 10% 1/10W <sup>o</sup>	24341-265	V5	EF184	28154-627
RV1	Carb 680 $\Omega$ 20% $\frac{1}{4}$ W	25611-112	V6	EZ81	28114-287
RV2	Carb 1M $\Omega$ 20% $\frac{1}{4}$ W	25611-150	V7	EL81	28154-297
RV3	Carb 2.2k $\Omega$ 20% $\frac{1}{4}$ W*	25611-206	V8	6AK5	28152-482
RV4	Carb 100 $\Omega$ 20% $\frac{1}{4}$ W*	25611-242	V9	85A2	28216-237
RV5	Carb 4.7k $\Omega$ 20% $\frac{1}{4}$ W	25611-134			
SAB	Oak DH 3-sec. 12-pos.	44423-001		Fuse holder	23416-191
SAD	Oak DH 3-sec. 12-pos.	44423-001		Handle assembly	22315-515
SAE	Oak DH 3-sec. 12-pos.	44423-001		Mains lead	43121-707
SAF	Oak DH 3-sec. 12-pos.	44423-001		Mains tapping panel	43218-015
SB	D.P.D.T. toggle	44334-003		Range knob	41145-206
				Terminals miniature	23235-176
T1	Mains transformer	43463-018		Valve top cap connector	28237-443

For symbols and abbreviations see introduction to this chapter

**Circuit notes**

## 1. COMPONENT VALUES

Resistors: no suffix = ohms, k = kilohms, M = megohms

Capacitors: no suffix = microfarads, p = picofarads

† : value selected during test, nominal value shown.

## 2. VOLTAGES

Shown in italics adjacent to the point to which measurement refers. Measure with an Avometer under normal conditions.

## 3. SYMBOLS

➔ arrow indicates clockwise rotation of knob.

**RANGE** etc., external front or rear panel marking.

—<sup>2</sup>— tag on printed board.

—○ switch wafer pin.

⊙ preset control.

## 4. CIRCUIT REFERENCES

These are, in general, given in abbreviated form.

See also introduction to Chapter 6.

## 5. SWITCHES

Letters indicate control knob settings.

SAb = 1st section (front panel) back

SAd = 2nd section, back

SAe = 3rd section, front

SAf = 3rd section, back

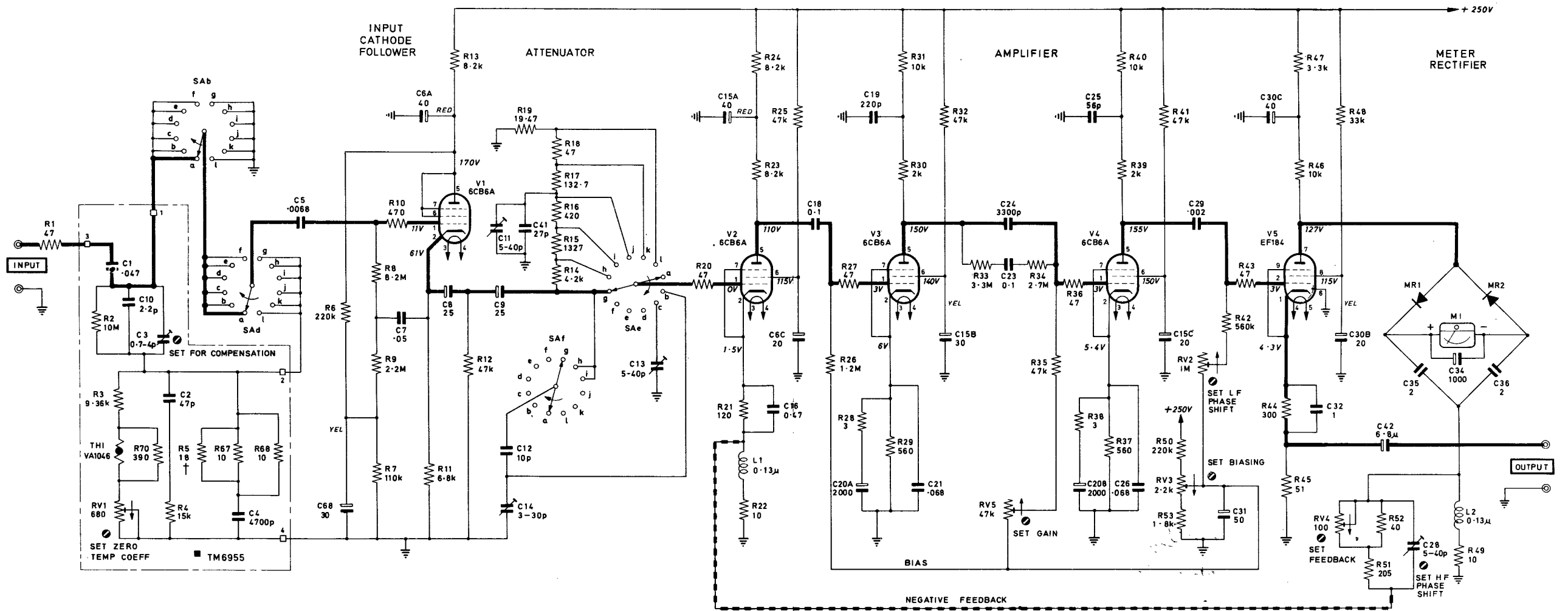

C11, C13, C14 are adjusted for optimum high frequency response.

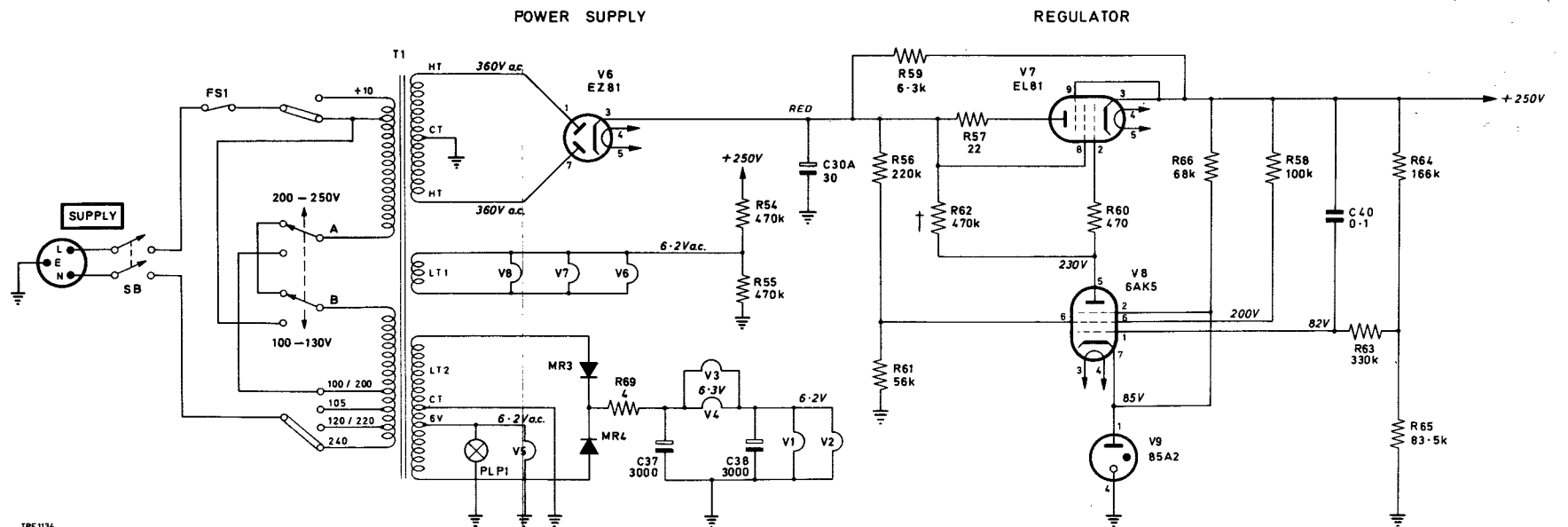
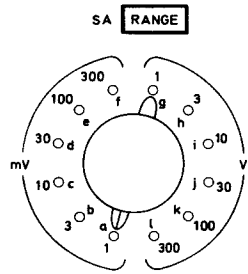

Fig. 7.1 Circuit diagram

Circuit reference

- R63 Carb 330k
- R64 Met ox 16
- R65 Met ox 83
- R66 Carb 68k $\Omega$
- R67 Carb 10 $\Omega$
- R68 Carb 10 $\Omega$
- R69 WW 4 $\Omega$  5%
- R70 Carb 390 $\Omega$
  
- RV1 Carb 680 $\Omega$
- RV2 Carb 1M $\Omega$
- RV3 Carb 2.2k
- RV4 Carb 100 $\Omega$
- RV5 Carb 4.7k $\Omega$
  
- SAB Oak DH 3-
- SAD Oak DH 3-
- SAE Oak DH 3-
- SAF Oak DH 3-
- SB D.P.D.T.
  
- T1 Mains tra

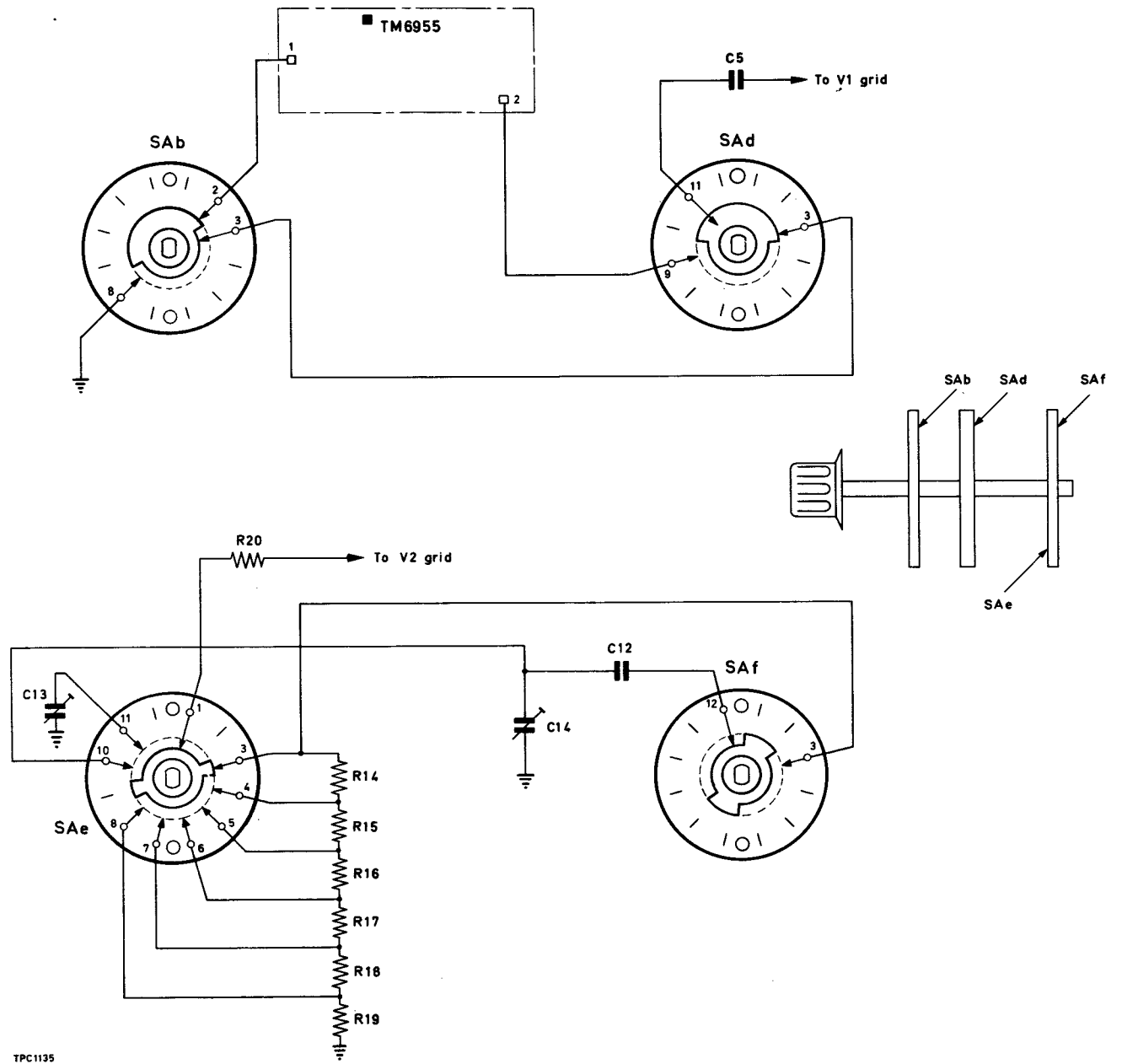

Fig. 7.2 Arrangement of switch SA